



2SB649/A

PNP SILICON TRANSISTOR

BIPOLAR POWER GENERAL PURPOSE TRANSISTOR

■ APPLICATIONS

* Low frequency power amplifier complementary pair with UTC 2SB669/A

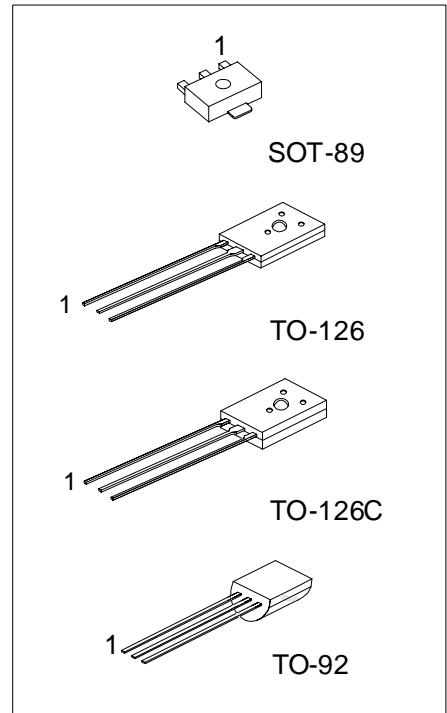

*Pb-free plating product number:
2SB649L/2SB649AL

■ ORDERING INFORMATION

Order Number		Package	Pin Assignment			Packing
Normal	Lead Free Plating		1	2	3	
2SB649-x-AB3-R	2SB649L-x-AB3-R	SOT-89	B	C	E	Tape Reel
2SB649-x-T6C-K	2SB649L-x-T6C-K	TO-126C	E	C	B	Bulk
2SB649-x-T60-K	2SB649L-x-T60-K	TO-126	E	C	B	Bulk
2SB649-x-T92-B	2SB649L-x-T92-B	TO-92	E	C	B	Tape Box
2SB649-x-T92-K	2SB649L-x-T92-K	TO-92	E	C	B	Bulk
2SB649A-x-AB3-R	2SB649AL-x-AB3-R	SOT-89	B	C	E	Tape Reel
2SB649A-x-T6C-K	2SB649AL-x-T6C-K	TO-126C	E	C	B	Bulk
2SB649A-x-T60-K	2SB649AL-x-T60-K	TO-126	E	C	B	Bulk
2SB649A-x-T92-B	2SB649AL-x-T92-B	TO-92	E	C	B	Tape Box
2SB649A-x-T92-K	2SB649AL-x-T92-K	TO-92	E	C	B	Bulk

<p>2SB649L-x-AB3-R</p> <p>(1)Packing Type (2)Package Type (3)Rank (4)Lead Plating</p>	<p>(1) B: Tape Box, K: Bulk, R: Tape Reel (2) AB3: SOT-89, T6C: TO-126C, T60: TO-126, T92: TO-92 (3) x: refer to Classification of h_{FE} (4) L: Lead Free Plating, Blank: Pb/Sn</p>
---	---

■ ABSOLUTE MAXIMUM RATING (Ta=25 , unless otherwise specified)

PARAMETER		SYMBOL	RATING	UNIT
Collector-Base Voltage		V_{CBO}	-180	V
Collector-Emitter Voltage	2SB649	V_{CEO}	-120	V
	2SB649A		-160	
Emitter-Base Voltage		V_{EBO}	-5	V
Collector Current		I_C	-1.5	A
Collector Peak Current		$I_{C(PK)}$	-3	A
Collector Power Dissipation	TO-126/TO-126C	P_D	1.4	W
	TO-92		1	W
	SOT-89		500	mW
Junction Temperature		T_J	+150	°C
Storage Temperature		T_{STG}	-40 ~ +150	°C

Note: Absolute maximum ratings are those values beyond which the device could be permanently damaged.

Absolute maximum ratings are stress ratings only and functional device operation is not implied.

■ ELECTRICAL CHARACTERISTICS (Ta=25 , unless otherwise specified)

PARAMETER		SYMBOL	TEST CONDITIONS	MIN	TYP	MAX	UNIT
Collector to Base Breakdown Voltage		BV_{CBO}	$I_C=-1mA, I_E=0$	-180			V
Collector to Emitter Breakdown Voltage	2SB649	BV_{CEO}	$I_C=-10mA, R_{BE}=\infty$	-120			V
	2SB649A			-160			
Emitter to Base Breakdown Voltage		BV_{EBO}	$I_E=-1mA, I_C=0$	-5			V
Collector Cut-off Current		I_{CBO}	$V_{CB}=-160V, I_E=0$			-10	μA
DC Current Gain	2SB649	h_{FE1}	$V_{CE}=-5V, I_C=-150mA$ (note)	60		320	
		h_{FE2}	$V_{CE}=-5V, I_C=-500mA$ (note)	30			
	2SB649A	h_{FE1}	$V_{CE}=-5V, I_C=-150mA$ (note)	60		200	
		h_{FE2}	$V_{CE}=-5V, I_C=-500mA$ (note)	30			
Collector-Emitter Saturation Voltage		$V_{CE(SAT)}$	$I_C=-600mA, I_B=-50mA$			-1	V
Base-Emitter Voltage		V_{BE}	$V_{CE}=-5V, I_C=-150mA$			-1.5	V
Current Gain Bandwidth Product		f_T	$V_{CE}=-5V, I_C=-150mA$		140		MHz
Output Capacitance		C_{ob}	$V_{CB}=-10V, I_E=0, f=1MHz$		27		pF

Note: Pulse test.

■ CLASSIFICATION OF h_{FE}

RANK	B	C	D
RANGE	60-120	100-200	160-320

TYPICAL CHARACTERISTICS

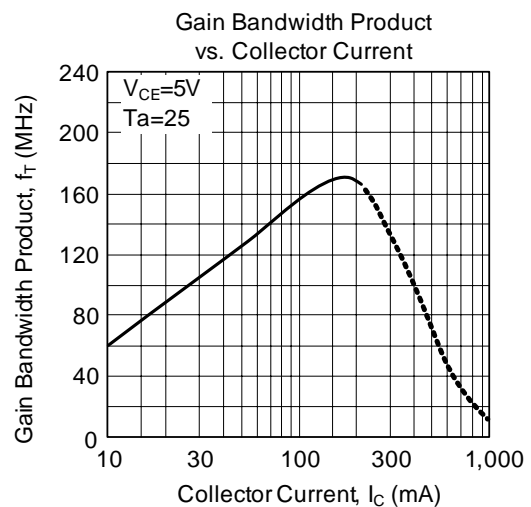
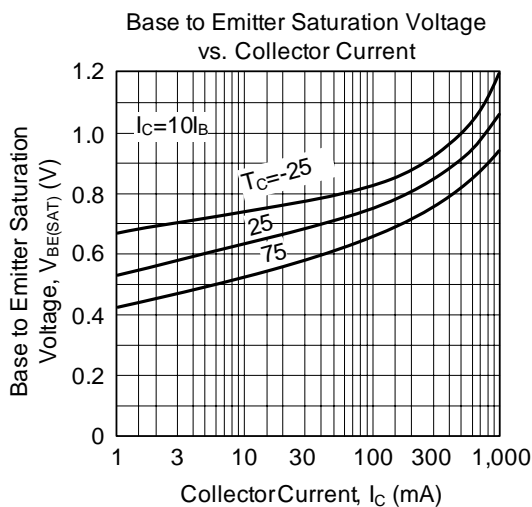
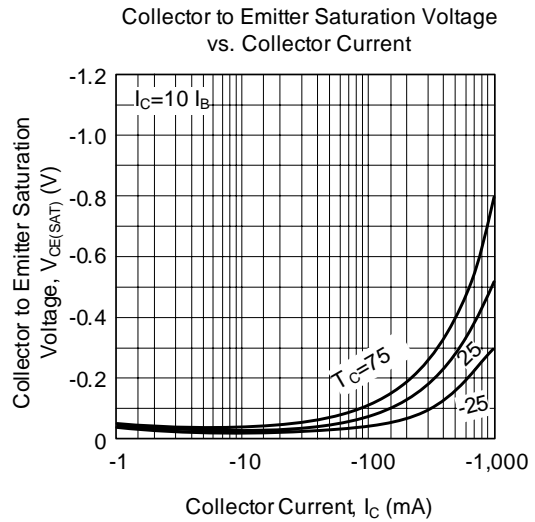
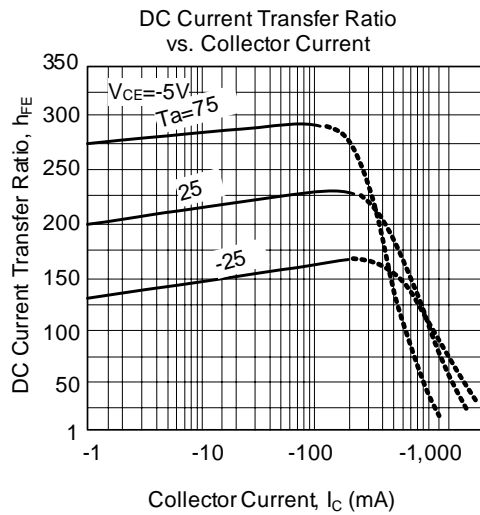
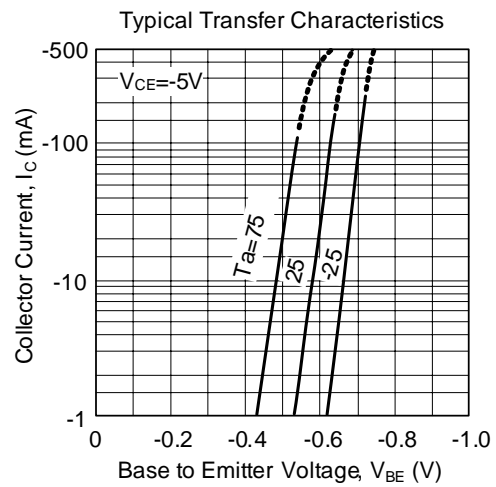
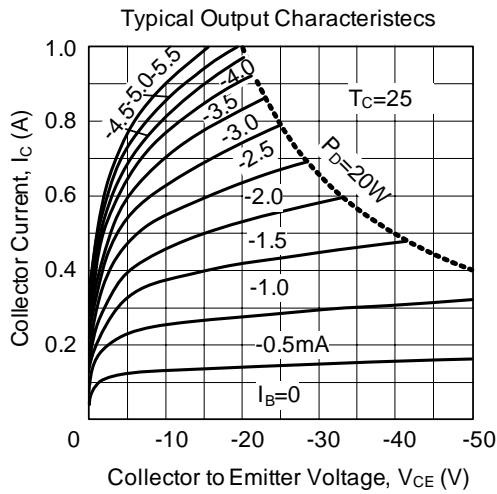

■ TYPICAL CHARACTERISTICS(Cont.)

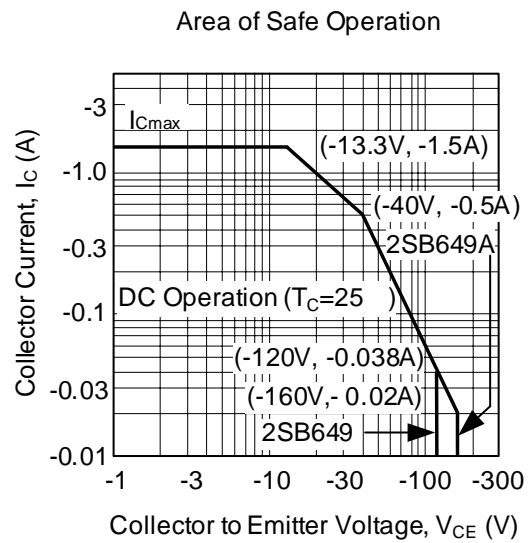
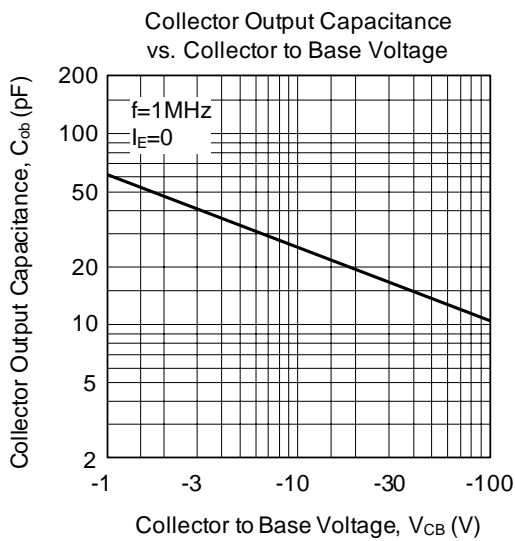

UTC assumes no responsibility for equipment failures that result from using products at values that exceed, even momentarily, rated values (such as maximum ratings, operating condition ranges, or other parameters) listed in products specifications of any and all UTC products described or contained herein. UTC products are not designed for use in life support appliances, devices or systems where malfunction of these products can be reasonably expected to result in personal injury. Reproduction in whole or in part is prohibited without the prior written consent of the copyright owner. The information presented in this document does not form part of any quotation or contract, is believed to be accurate and reliable and may be changed without notice.