

1-A, Positive Fixed Voltage, Low-Dropout Regulator

FEATURES

- **1.5% Typical Accuracy**
- **Low I_Q : 100 μ A (max)**
 - **500 times lower than standard 1117 devices**
- **V_{IN} : 2.0 V to 5.5 V**
 - **Absolute maximum $V_{IN} = 6.0$ V**
- **Stable with 0-mA Output Current**
- **Low Dropout: 455 mV at 1 A for $V_{OUT} = 3.3$ V**
- **High PSRR: 65 dB at 1 kHz**
- **Minimum Ensured Current Limit: 1.1 A**
- **Stable with Cost-Effective Ceramic Capacitors:**
 - **With 0- Ω ESR**
- **Temperature Range: -40°C to $+125^\circ\text{C}$**
- **Thermal Shutdown and Overcurrent Protection**
- **Available in SOT223 Package**
 - **See *Package Option Addendum* at end of this document for complete list of available voltage options**

APPLICATIONS

- **Set Top Boxes**
- **TVs and Monitors**
- **PC Peripherals, Notebooks, Motherboards**
- **Modems and Other Communication Products**
- **Switching Power Supply Post-Regulation**

DESCRIPTION

The TLV1117LV series of low-dropout (LDO) linear regulators is a low input voltage version of the popular 1117 voltage regulator.

The TLV1117LV is an extremely low-power device that consumes 500 times lower quiescent current than traditional 1117 voltage regulators, making it suitable for applications that mandate very low standby current. The TLV1117LV family of LDOs is also stable with 0 mA of load current; there is no minimum load requirement, making it an ideal choice for applications where the regulator is required to power very small loads during standby in addition to large currents on the order of 1 A during normal operation. The TLV1117LV offers excellent line and load transient performance, resulting in very small magnitude undershoots and overshoots of output voltage when the load current requirement changes from less than 1 mA to more than 500 mA.

A precision bandgap and error amplifier provides 1.5% accuracy. A very high power-supply rejection ratio enables usage of the device for post-regulation after a switching regulator. Other valuable features include low output noise and low-dropout voltage.

The device is internally compensated to be stable with 0- Ω equivalent series resistance (ESR) capacitors. These key advantages enable the use of cost-effective, small-size ceramic capacitors. Cost-effective capacitors that have higher bias voltages and temperature derating can also be used if desired.

The TLV1117LV series is available in a SOT223 package.

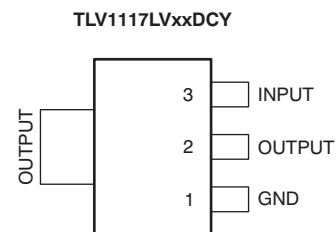

Figure 1.



Please be aware that an important notice concerning availability, standard warranty, and use in critical applications of Texas Instruments semiconductor products and disclaimers thereto appears at the end of this data sheet.

All trademarks are the property of their respective owners.



This integrated circuit can be damaged by ESD. Texas Instruments recommends that all integrated circuits be handled with appropriate precautions. Failure to observe proper handling and installation procedures can cause damage.

ESD damage can range from subtle performance degradation to complete device failure. Precision integrated circuits may be more susceptible to damage because very small parametric changes could cause the device not to meet its published specifications.

ORDERING INFORMATION⁽¹⁾

| PRODUCT | V _{OUT} |
|---------------------|---|
| TLV1117LVvv(A)yyyyz | VV is the nominal output voltage (for example, 33 = 3.3 V). YYY is the package designator. Z is the package quantity. Use <i>R</i> for reel (2500 pieces), and <i>T</i> for tape (250 pieces). |

(1) For the most current package and ordering information see the Package Option Addendum at the end of this document, or visit the device product folder at www.ti.com.

ABSOLUTE MAXIMUM RATINGS⁽¹⁾

At T_J = +25°C (unless otherwise noted). All voltages are with respect to GND.

| | | VALUE | | UNIT |
|------------------------------------|--|---|------|------|
| | | MIN | MAX | |
| Voltage | Input voltage range, V _{IN} | -0.3 | +6.0 | V |
| | Output voltage range, V _{OUT} | -0.3 | +6.0 | V |
| Current | Maximum output current, I _{OUT} | Internally limited | | |
| Output short-circuit duration | | Indefinite | | |
| Continuous total power dissipation | P _{DISS} | See Dissipation Ratings Table | | |
| Temperature | Operating junction, T _J | -55 | +150 | °C |
| | Storage, T _{stg} | -55 | +150 | °C |
| Electrostatic Discharge Ratings | Human body model (HBM) QSS 009-105 (JESD22-A114A) | 2 | | kV |
| | Charged device model (CDM) QSS 009-147 (JESD22-C101B.01) | 500 | | V |

(1) Stresses beyond those listed under *absolute maximum ratings* may cause permanent damage to the device. These are stress ratings only, and functional operation of the device at these or any other conditions beyond those indicated under *recommended operating conditions* is not implied. Exposure to absolute-maximum-rated conditions for extended periods may affect device reliability.

THERMAL INFORMATION

| THERMAL METRIC ⁽¹⁾ | | TLV1117LV | | UNITS |
|-------------------------------|--|-----------|--|-------|
| | | DCY | | |
| | | 3 PINS | | |
| θ _{JA} | Junction-to-ambient thermal resistance | 62.9 | | °C/W |
| θ _{JCtop} | Junction-to-case (top) thermal resistance | 47.2 | | |
| θ _{JB} | Junction-to-board thermal resistance | 12.0 | | |
| ψ _{JT} | Junction-to-top characterization parameter | 6.1 | | |
| ψ _{JB} | Junction-to-board characterization parameter | 11.9 | | |
| θ _{JCbot} | Junction-to-case (bottom) thermal resistance | N/A | | |

(1) For more information about traditional and new thermal metrics, see the [IC Package Thermal Metrics](#) application report, [SPRA953A](#).

DISSIPATION RATINGS

| BOARD | PACKAGE | R _{θJC} | R _{θJA} | T _A < +25°C |
|-----------------------|---------|------------------|------------------|------------------------|
| High-K ⁽¹⁾ | DCY | 47.2 | 62.9 | 1.59 W |

(1) The JEDEC high K (2s2p) board used to derive these data was a 3-inch x 3-inch, multilayer board with 1-ounce internal power and ground planes and 2-ounce copper traces on top and bottom of the board.

ELECTRICAL CHARACTERISTICS

At $V_{IN} = V_{OUT(TYP)} + 1.5\text{ V}$; $I_{OUT} = 10\text{ mA}$, $C_{OUT} = 1.0\text{ }\mu\text{F}$, and $T_A = +25^\circ\text{C}$, unless otherwise noted.

| PARAMETER | | TEST CONDITIONS | | TLV1117LV Series | | | UNIT |
|-----------------------------|--------------------------------|--|---------------------------|---------------------------|------|------|---------------------|
| | | | | MIN | TYP | MAX | |
| V_{IN} | Input voltage range | | | 2.0 | 5.5 | | V |
| V_{OUT} | DC output accuracy | $V_{OUT} > 2\text{ V}$ | | -1.5 | +1.5 | | % |
| | | $1.5\text{ V} \leq V_{OUT} < 2\text{ V}$ | | -2 | +2 | | % |
| | | $1.2\text{ V} \leq V_{OUT} < 1.5\text{ V}$ | | -40 | +40 | | mV |
| $\Delta V_O/\Delta V_{IN}$ | Line regulation | $V_{OUT(NOM)} + 0.5\text{ V} \leq V_{IN} \leq 5.5\text{ V}$, $I_{OUT} = 10\text{ mA}$ | | | 1 | 5 | mV |
| $\Delta V_O/\Delta I_{OUT}$ | Load regulation | $0\text{ mA} \leq I_{OUT} \leq 1\text{ A}$ | | | 1 | 35 | mV |
| V_{DO} | Dropout voltage ⁽¹⁾ | $V_{IN} = 0.98 \times V_{OUT(NOM)}$ | $V_{OUT} < 3.3\text{ V}$ | $I_{OUT} = 200\text{ mA}$ | 115 | | mV |
| | | | | $I_{OUT} = 500\text{ mA}$ | 285 | | mV |
| | | | | $I_{OUT} = 800\text{ mA}$ | 455 | | mV |
| | | | | $I_{OUT} = 1\text{ A}$ | 570 | 800 | mV |
| | | $V_{OUT} \geq 3.3\text{ V}$ | $I_{OUT} = 200\text{ mA}$ | 90 | | mV | |
| | | | $I_{OUT} = 500\text{ mA}$ | 230 | | mV | |
| | | | $I_{OUT} = 800\text{ mA}$ | 365 | | mV | |
| | | | $I_{OUT} = 1\text{ A}$ | 455 | 700 | mV | |
| I_{CL} | Output current limit | $V_{OUT} = 0.9 \times V_{OUT(NOM)}$ | | 1.1 | | | A |
| I_Q | Quiescent current | $I_{OUT} = 0\text{ mA}$ | | | 50 | 100 | μA |
| PSRR | Power-supply rejection ratio | $V_{IN} = 3.3\text{ V}$, $V_{OUT} = 1.8\text{ V}$, $I_{OUT} = 500\text{ mA}$, $f = 100\text{ Hz}$ | | | 65 | | dB |
| V_N | Output noise voltage | BW = 10 Hz to 100 kHz, $V_{IN} = 2.8\text{ V}$, $V_{OUT} = 1.8\text{ V}$, $I_{OUT} = 500\text{ mA}$ | | | 60 | | μV_{RMS} |
| t_{STR} | Startup time ⁽²⁾ | $C_{OUT} = 1.0\text{ }\mu\text{F}$, $I_{OUT} = 1\text{ A}$ | | | 100 | | μs |
| UVLO | Undervoltage lockout | V_{IN} rising | | | 1.95 | | V |
| T_{SD} | Thermal shutdown temperature | Shutdown, temperature increasing | | | +165 | | $^\circ\text{C}$ |
| | | Reset, temperature decreasing | | | +145 | | $^\circ\text{C}$ |
| T_J | Operating junction temperature | | | -40 | | +125 | $^\circ\text{C}$ |

(1) V_{DO} is measured for devices with $V_{OUT(NOM)} = 2.5\text{ V}$ so that $V_{IN} = 2.45\text{ V}$.

(2) Startup time = time from when V_{IN} asserts to when output is sustained at a value greater than or equal to $0.98 \times V_{OUT(NOM)}$.

FUNCTIONAL BLOCK DIAGRAM

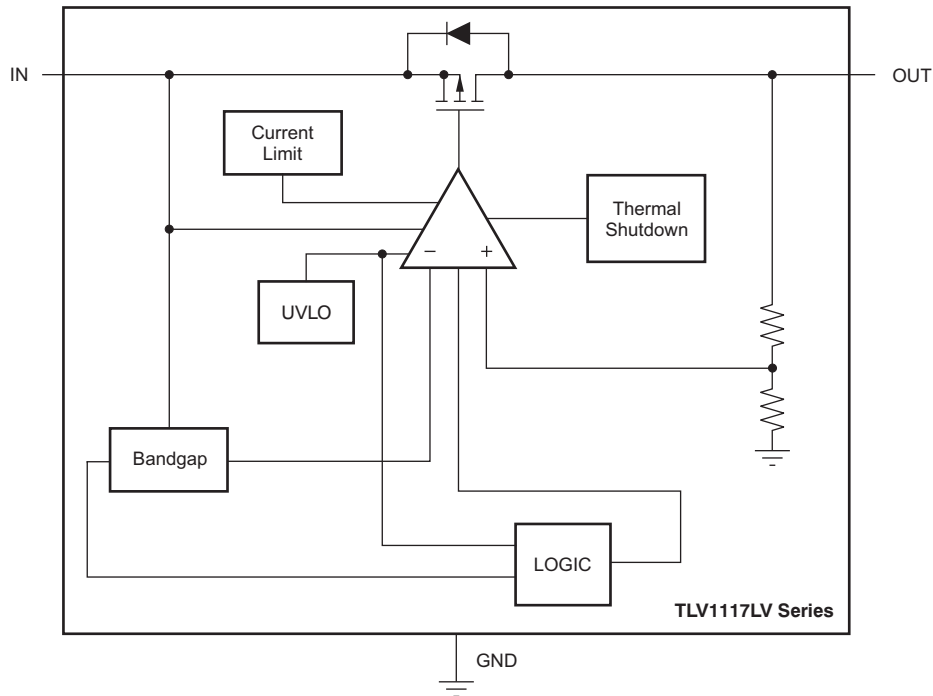
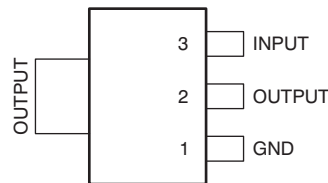

Figure 2. TLV1117LV Block Diagram

PIN CONFIGURATIONS

DCY PACKAGE
SOT223
(TOP VIEW)



PIN DESCRIPTIONS

| TLV1117LV ⁽¹⁾ | | DESCRIPTION |
|--------------------------|--------------|--|
| NAME | TLV1117LVDCY | |
| IN | 3 | Input pin. See <i>Input and Output Capacitor Requirements</i> in the <i>Application Information</i> section for more details. |
| OUT | 2, Tab | Regulated output voltage pin. See <i>Input and Output Capacitor Requirements</i> in the <i>Application Information</i> section for more details. |
| GND | 1 | Ground pin |

(1) Shaded cells indicate preview device.

TYPICAL CHARACTERISTICS

At $V_{IN} = V_{OUT(TYP)} + 1.5\text{ V}$; $I_{OUT} = 10\text{ mA}$, $C_{OUT} = 1.0\text{ }\mu\text{F}$, and $T_A = +25^\circ\text{C}$, unless otherwise noted.

LINE REGULATION

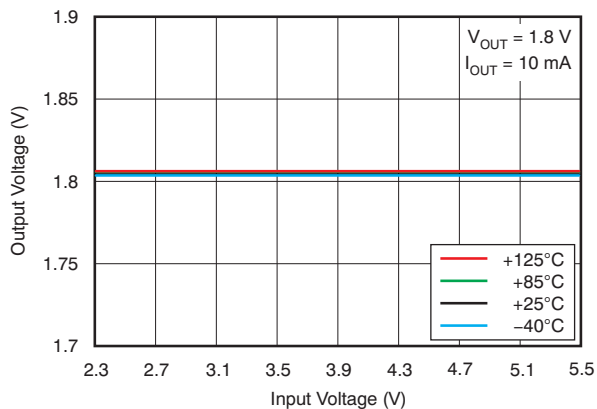

Figure 3.

LINE REGULATION

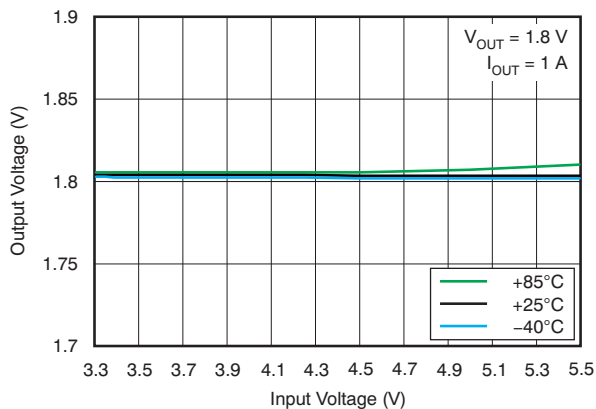

Figure 4.

LOAD REGULATION

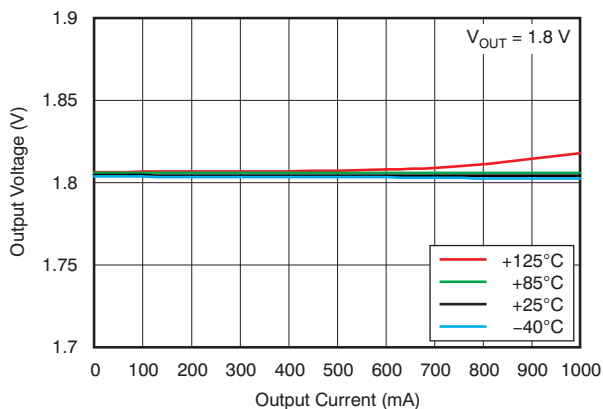

Figure 5.

DROPOUT VOLTAGE vs INPUT

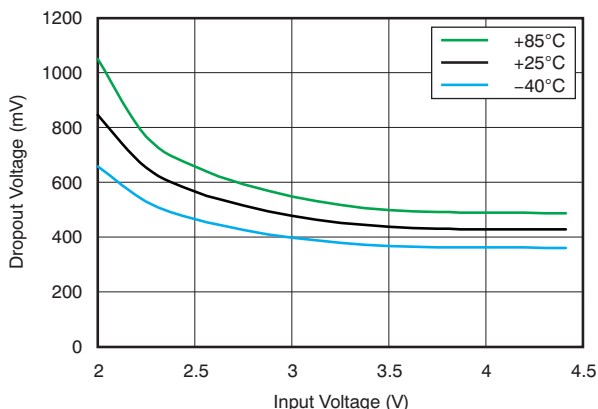

Figure 6.

DROPOUT VOLTAGE vs OUTPUT

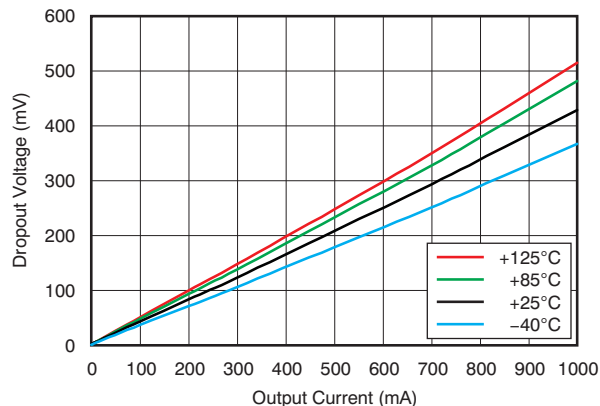

Figure 7.

OUTPUT VOLTAGE vs TEMPERATURE

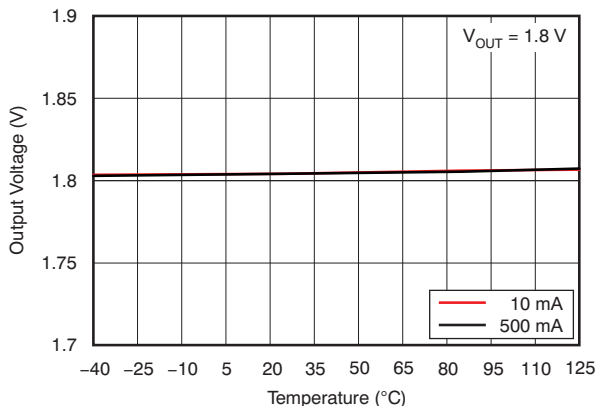

Figure 8.

TYPICAL CHARACTERISTICS (continued)

At $V_{IN} = V_{OUT(TYP)} + 1.5\text{ V}$; $I_{OUT} = 10\text{ mA}$, $C_{OUT} = 1.0\text{ }\mu\text{F}$, and $T_A = +25^\circ\text{C}$, unless otherwise noted.

QUIESCENT CURRENT vs LOAD

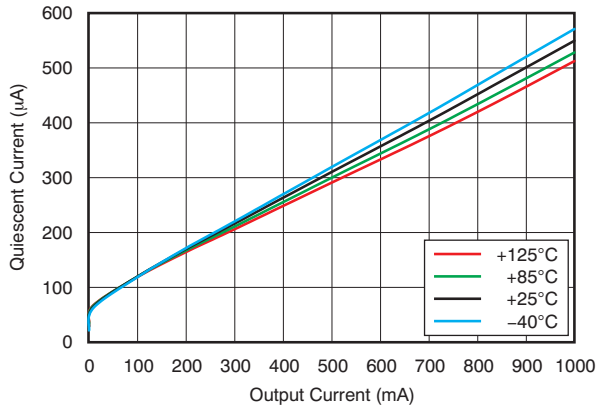

Figure 9.

CURRENT LIMIT vs INPUT VOLTAGE

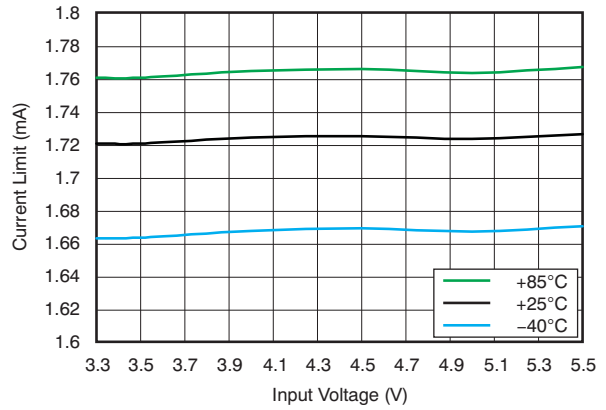

Figure 10.

POWER-SUPPLY REJECTION RATIO vs FREQUENCY

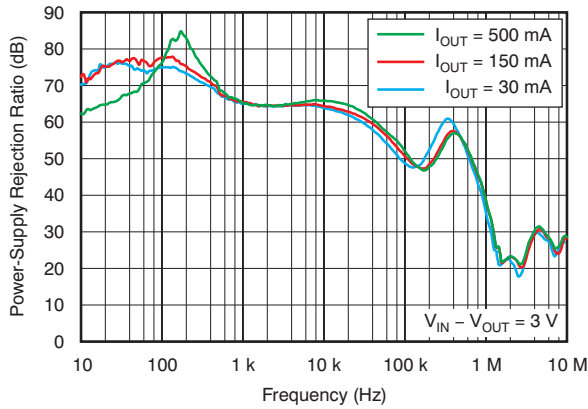

Figure 11.

POWER-SUPPLY REJECTION RATIO vs FREQUENCY

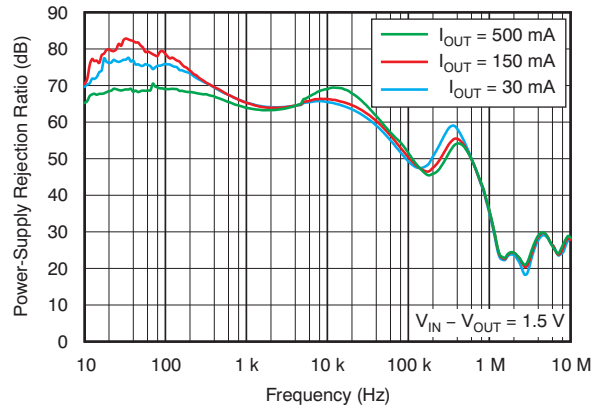

Figure 12.

POWER-SUPPLY REJECTION RATIO vs OUTPUT CURRENT

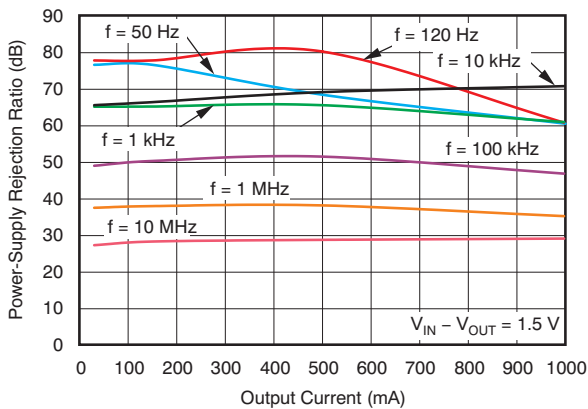

Figure 13.

SPECTRAL NOISE DENSITY vs FREQUENCY

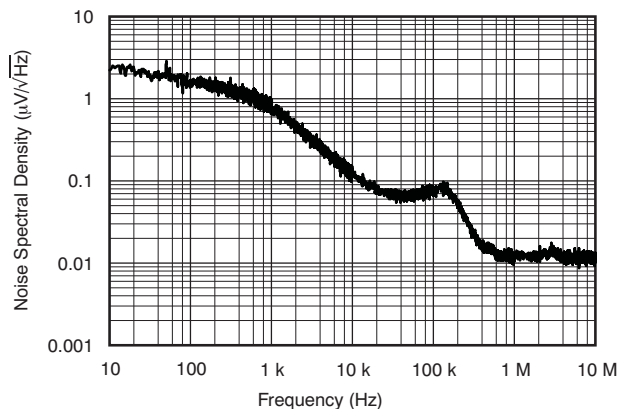

Figure 14.

TYPICAL CHARACTERISTICS (continued)

At $V_{IN} = V_{OUT(TYP)} + 1.5\text{ V}$; $I_{OUT} = 10\text{ mA}$, $C_{OUT} = 1.0\text{ }\mu\text{F}$, and $T_A = +25^\circ\text{C}$, unless otherwise noted.

LOAD TRANSIENT RESPONSE
200 mA to 500 mA, $C_{OUT} = 1\text{ }\mu\text{F}$

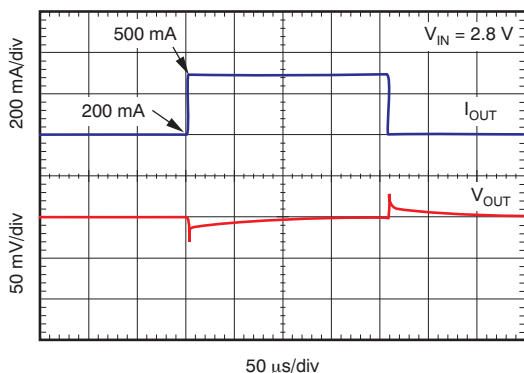

Figure 15.

LOAD TRANSIENT RESPONSE
200 mA to 500 mA, $C_{OUT} = 10\text{ }\mu\text{F}$

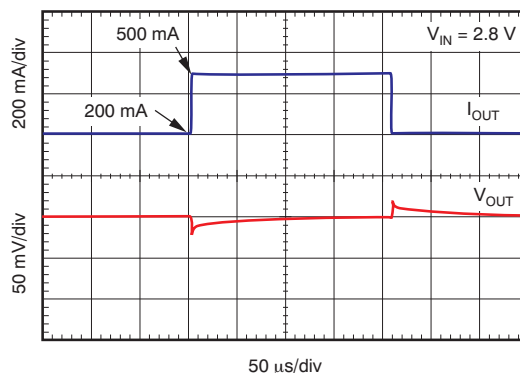

Figure 16.

LOAD TRANSIENT RESPONSE
1 mA to 500 mA, $C_{OUT} = 1\text{ }\mu\text{F}$

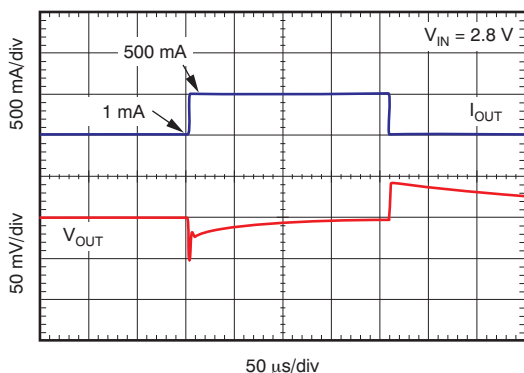

Figure 17.

LOAD TRANSIENT RESPONSE
1 mA to 500 mA, $C_{OUT} = 10\text{ }\mu\text{F}$

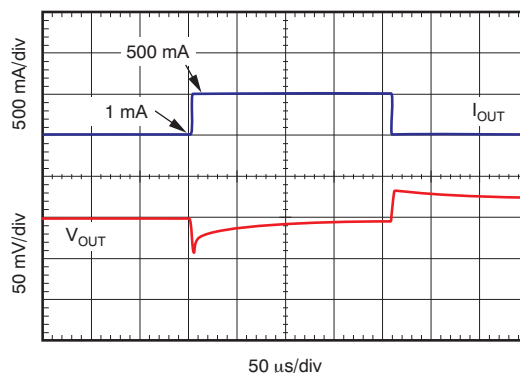

Figure 18.

LOAD TRANSIENT RESPONSE
200 mA to 1 A, $C_{OUT} = 1\text{ }\mu\text{F}$

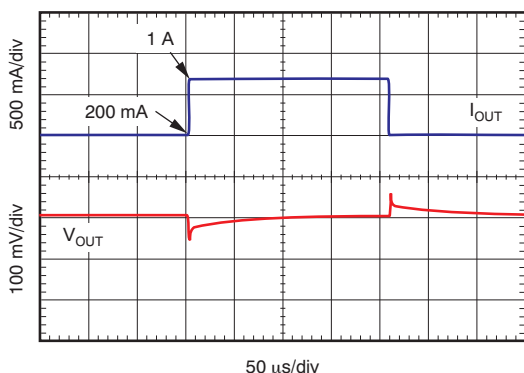

Figure 19.

LOAD TRANSIENT RESPONSE
200 mA to 1 A, $C_{OUT} = 10\text{ }\mu\text{F}$

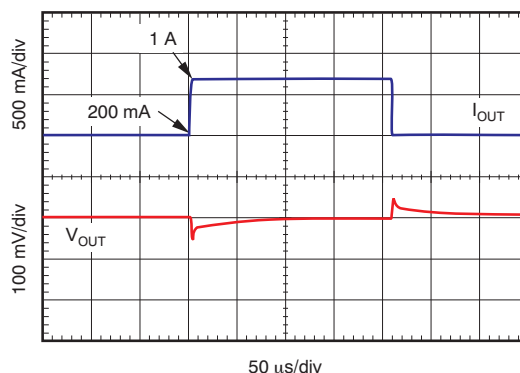

Figure 20.

TYPICAL CHARACTERISTICS (continued)

At $V_{IN} = V_{OUT(TYP)} + 1.5\text{ V}$; $I_{OUT} = 10\text{ mA}$, $C_{OUT} = 1.0\text{ }\mu\text{F}$, and $T_A = +25^\circ\text{C}$, unless otherwise noted.

LOAD TRANSIENT RESPONSE
1 mA to 1 A, $C_{OUT} = 1\text{ }\mu\text{F}$

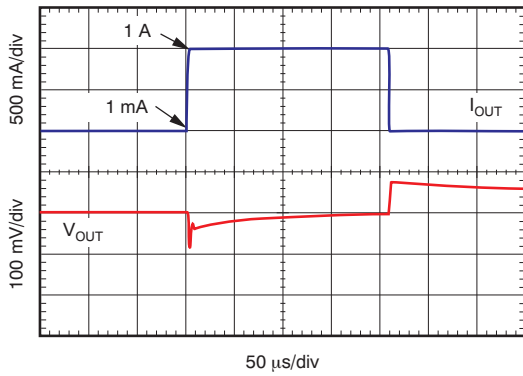

Figure 21.

LOAD TRANSIENT RESPONSE
1 mA to 1 A, $C_{OUT} = 10\text{ }\mu\text{F}$

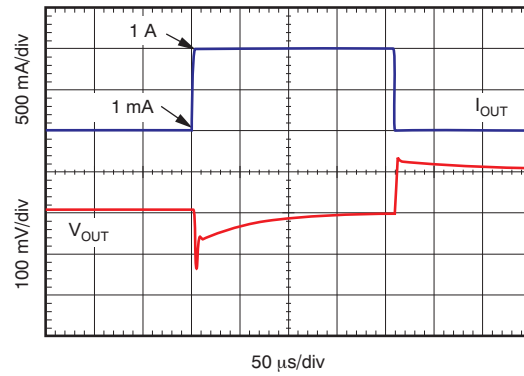

Figure 22.

LINE TRANSIENT RESPONSE
 $V_{OUT} = 1.8\text{ V}$, $I_{OUT} = 10\text{ mA}$

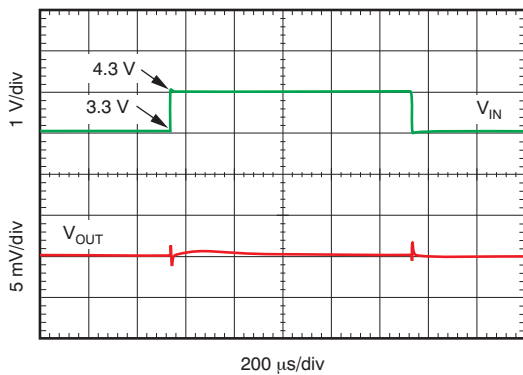

Figure 23.

LINE TRANSIENT RESPONSE
 $V_{OUT} = 1.8\text{ V}$, $I_{OUT} = 500\text{ mA}$

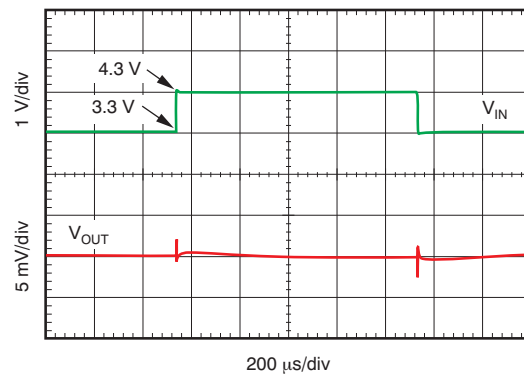

Figure 24.

LINE TRANSIENT RESPONSE
 $V_{OUT} = 1.8\text{ V}$, $I_{OUT} = 1\text{ A}$

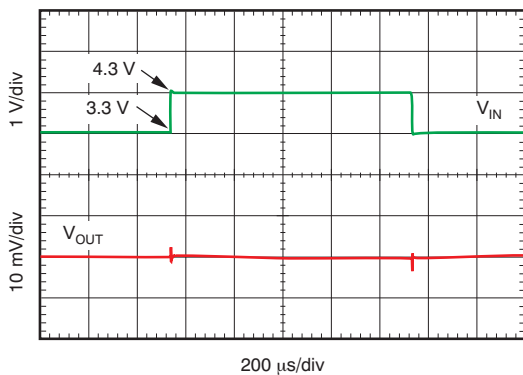

Figure 25.

LINE TRANSIENT RESPONSE
 $V_{OUT} = 1.8\text{ V}$, $I_{OUT} = 10\text{ mA}$

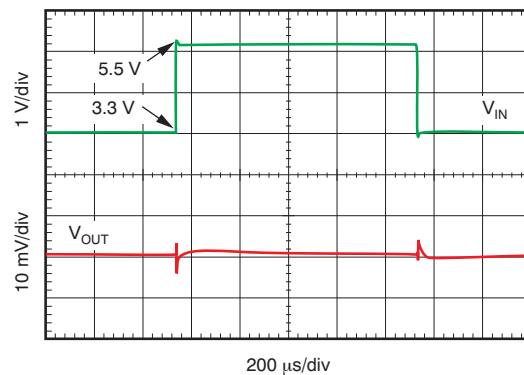

Figure 26.

TYPICAL CHARACTERISTICS (continued)

At $V_{IN} = V_{OUT(TYP)} + 1.5\text{ V}$; $I_{OUT} = 10\text{ mA}$, $C_{OUT} = 1.0\text{ }\mu\text{F}$, and $T_A = +25^\circ\text{C}$, unless otherwise noted.

LINE TRANSIENT RESPONSE
 $V_{OUT} = 1.8\text{ V}$, $I_{OUT} = 500\text{ mA}$

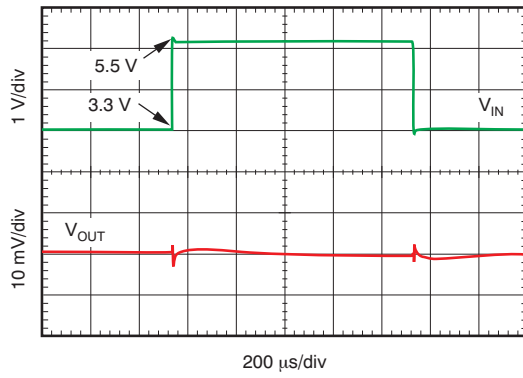

Figure 27.

LINE TRANSIENT RESPONSE
 $V_{OUT} = 1.8\text{ V}$, $I_{OUT} = 1\text{ A}$

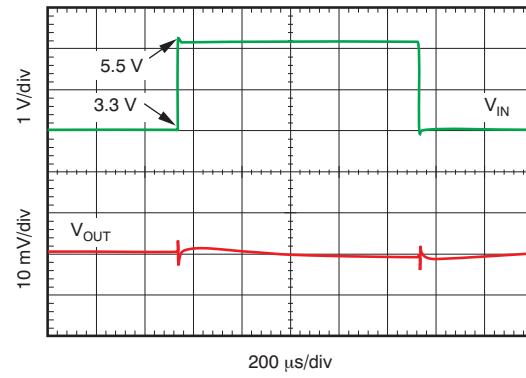

Figure 28.

APPLICATION INFORMATION

The TLV1117LV is a low quiescent current linear regulator designed for high current applications. Unlike typical high current linear regulators, the TLV1117LV series consume significantly less quiescent current. These devices deliver excellent line and load transient performance. The device is low noise, and exhibits a very good power-supply rejection ratio (PSRR). As a result, it is ideal for high current applications that require very sensitive power-supply rails.

This family of regulators offers both current limit and thermal protection. The operating junction temperature range of the device is -40°C to $+125^{\circ}\text{C}$.

Input and Output Capacitor Requirements

For stability, 1.0- μF ceramic capacitors are required at the output. Higher-valued capacitors improve transient performance. X5R- and X7R-type ceramic capacitors are recommended because these capacitors have minimal variation in value and equivalent series resistance (ESR) over temperature. Unlike traditional linear regulators that need a minimum ESR for stability, the TLV1117LV series are ensured to be stable with no ESR. Therefore, cost-effective ceramic capacitors can be used with these devices. Effective output capacitance that takes bias, temperature, and aging effects into consideration must be greater than 0.5 μF to ensure stability of the device.

Although an input capacitor is not required for stability, it is good analog design practice to connect a 0.1- μF to 1.0- μF , low-ESR capacitor across the IN pin and GND pin of the regulator. This capacitor counteracts reactive input sources and improves transient response, noise rejection, and ripple rejection. A higher-value capacitor may be necessary if large, fast rise-time load transients are anticipated, or if the device is not located physically close to the power source. If source impedance is greater than 2 Ω , a 0.1- μF input capacitor may also be necessary to ensure stability.

Board Layout Recommendations to Improve PSRR and Noise Performance

Input and output capacitors should be placed as close to the device pins as possible. To improve characteristic ac performance such as PSRR, output noise, and transient response, it is recommended that the board be designed with separate ground planes for V_{IN} and V_{OUT} , with the ground plane connected only at the GND pin of the device. In addition, the ground connection for the output capacitor should be connected directly to the GND pin of the device. Higher value ESR capacitors may degrade PSRR performance.

Internal Current Limit

The TLV1117LV internal current limit helps to protect the regulator during fault conditions. During current limit, the output sources a fixed amount of current that is largely independent of the output voltage. In such a case, the output voltage is not regulated, and can be calculated by the formula: $V_{\text{OUT}} = I_{\text{LIMIT}} \times R_{\text{LOAD}}$. The PMOS pass transistor dissipates $(V_{\text{IN}} - V_{\text{OUT}}) \times I_{\text{LIMIT}}$ until thermal shutdown is triggered and the device turns off. As the device cools down, it is turned on by the internal thermal shutdown circuit. If the fault condition continues, the device cycles between current limit and thermal shutdown. See the [Thermal Information](#) section for more details.

The PMOS pass element in the TLV1117LV device has a built-in body diode that conducts current when the voltage at OUT exceeds the voltage at IN. This current is not limited; if extended reverse voltage operation is anticipated, external limiting to 5% of the rated output current is recommended.

Dropout Voltage

The TLV1117LV uses a PMOS pass transistor to achieve low dropout. When $(V_{\text{IN}} - V_{\text{OUT}})$ is less than the dropout voltage (V_{DO}), the PMOS pass device is in the linear region of operation and the input-to-output resistance is the $R_{\text{DS(ON)}}$ of the PMOS pass element. V_{DO} scales approximately with output current because the PMOS device behaves as a resistor in dropout.

As with any linear regulator, PSRR and transient response are degraded as $(V_{\text{IN}} - V_{\text{OUT}})$ approaches dropout.

Transient Response

As with any regulator, increasing the size of the output capacitor reduces over-/undershoot magnitude.

Undervoltage Lockout (UVLO)

The TLV1117LV uses an undervoltage lockout circuit keep the output shut off until internal circuitry operating properly.

Thermal Information

Thermal protection disables the output when the junction temperature rises to approximately +165°C, allowing the device to cool. When the junction temperature cools to approximately +145°C, the output circuitry is again enabled. Depending on power dissipation, thermal resistance, and ambient temperature, the thermal protection circuit may cycle on and off. This cycling limits the dissipation of the regulator, protecting it from damage as a result of overheating.

Any tendency to activate the thermal protection circuit indicates excessive power dissipation or an inadequate heatsink. For reliable operation, junction temperature should be limited to +125°C maximum. To estimate the margin of safety in a complete design (including heatsink), increase the ambient temperature until the thermal protection is triggered; use worst-case loads and signal conditions.

The internal protection circuitry of the TLV1117LV has been designed to protect against overload conditions. It was not intended to replace proper heatsinking. Continuously running the TLV1117LV into thermal shutdown degrades device reliability.

Power Dissipation

The ability to remove heat from the die is different for each package type, presenting different considerations in the printed circuit board (PCB) layout. The PCB area around the device that is free of other components moves the heat from the device to the ambient air. Performance data for JEDEC low and high-K boards are given in the [Dissipation Ratings](#) table. Using heavier copper increases the effectiveness in removing heat from the device. The addition of plated through-holes to heat-dissipating layers also improves heatsink effectiveness.

Power dissipation depends on input voltage and load conditions. Power dissipation (P_D) is equal to the product of the output current and the voltage drop across the output pass element, as shown in [Equation 1](#):

$$P_D = (V_{IN} - V_{OUT}) I_{OUT} \quad (1)$$

Package Mounting

Current solder pad footprint recommendations for the TLV1117LV are available from the Texas Instruments web site at www.ti.com. The mechanical drawing for the DCY (SOT223) package and the recommended land pattern for the DCY (SOT223) package are both appended to this data sheet.

REVISION HISTORY

NOTE: Page numbers from previous revisions may differ from page numbers in the current version.

| Changes from Original (May, 2011) to Revision A | Page |
|---|------|
| • Updated front-page figure | 1 |
| • Corrected errors in pin numbers listed in Pin Descriptions table and shown in device pinout | 4 |
| • Deleted example mechanical drawing and land pattern figures (Figure 29 and Figure 30, respectively) | 11 |

PACKAGING INFORMATION

| Orderable Device | Status (1) | Package Type | Package Drawing | Pins | Package Qty | Eco Plan (2) | Lead/Ball Finish | MSL Peak Temp (3) | Op Temp (°C) | Top-Side Markings (4) | Samples |
|------------------|---------------|--------------|--------------------|------|----------------|----------------------------|------------------|----------------------|--------------|--------------------------|-------------------------|
| TLV1117LV12DCYR | ACTIVE | SOT-223 | DCY | 4 | 2500 | Green (RoHS & no Sb/Br) | CU SN | Level-1-260C-UNLIM | -40 to 125 | SI | Samples |
| TLV1117LV12DCYT | ACTIVE | SOT-223 | DCY | 4 | 250 | Green (RoHS & no Sb/Br) | CU SN | Level-1-260C-UNLIM | -40 to 125 | SI | Samples |
| TLV1117LV15DCYR | ACTIVE | SOT-223 | DCY | 4 | 2500 | Green (RoHS & no Sb/Br) | CU SN | Level-1-260C-UNLIM | -40 to 125 | VR | Samples |
| TLV1117LV15DCYT | ACTIVE | SOT-223 | DCY | 4 | 250 | Green (RoHS & no Sb/Br) | CU SN | Level-1-260C-UNLIM | -40 to 125 | VR | Samples |
| TLV1117LV18DCYR | ACTIVE | SOT-223 | DCY | 4 | 2500 | Green (RoHS & no Sb/Br) | CU SN | Level-1-260C-UNLIM | -40 to 125 | SH | Samples |
| TLV1117LV18DCYT | ACTIVE | SOT-223 | DCY | 4 | 250 | Green (RoHS & no Sb/Br) | CU SN | Level-1-260C-UNLIM | -40 to 125 | SH | Samples |
| TLV1117LV25DCYR | ACTIVE | SOT-223 | DCY | 4 | 2500 | Green (RoHS & no Sb/Br) | CU SN | Level-1-260C-UNLIM | -40 to 125 | VS | Samples |
| TLV1117LV25DCYT | ACTIVE | SOT-223 | DCY | 4 | 250 | Green (RoHS & no Sb/Br) | CU SN | Level-1-260C-UNLIM | -40 to 125 | VS | Samples |
| TLV1117LV28DCYR | ACTIVE | SOT-223 | DCY | 4 | 2500 | Green (RoHS & no Sb/Br) | CU SN | Level-1-260C-UNLIM | -40 to 125 | VT | Samples |
| TLV1117LV28DCYT | ACTIVE | SOT-223 | DCY | 4 | 250 | Green (RoHS & no Sb/Br) | CU SN | Level-1-260C-UNLIM | -40 to 125 | VT | Samples |
| TLV1117LV30DCYR | ACTIVE | SOT-223 | DCY | 4 | 2500 | Green (RoHS & no Sb/Br) | CU SN | Level-1-260C-UNLIM | -40 to 125 | VU | Samples |
| TLV1117LV30DCYT | ACTIVE | SOT-223 | DCY | 4 | 250 | Green (RoHS & no Sb/Br) | CU SN | Level-1-260C-UNLIM | -40 to 125 | VU | Samples |
| TLV1117LV33DCYR | ACTIVE | SOT-223 | DCY | 4 | 2500 | Green (RoHS & no Sb/Br) | CU SN | Level-1-260C-UNLIM | -40 to 125 | TJ | Samples |
| TLV1117LV33DCYT | ACTIVE | SOT-223 | DCY | 4 | 250 | Green (RoHS & no Sb/Br) | CU SN | Level-1-260C-UNLIM | -40 to 125 | TJ | Samples |

(1) The marketing status values are defined as follows:

ACTIVE: Product device recommended for new designs.

LIFEBUY: TI has announced that the device will be discontinued, and a lifetime-buy period is in effect.

NRND: Not recommended for new designs. Device is in production to support existing customers, but TI does not recommend using this part in a new design.

PREVIEW: Device has been announced but is not in production. Samples may or may not be available.

OBSELETE: TI has discontinued the production of the device.

⁽²⁾ Eco Plan - The planned eco-friendly classification: Pb-Free (RoHS), Pb-Free (RoHS Exempt), or Green (RoHS & no Sb/Br) - please check <http://www.ti.com/productcontent> for the latest availability information and additional product content details.

TBD: The Pb-Free/Green conversion plan has not been defined.

Pb-Free (RoHS): TI's terms "Lead-Free" or "Pb-Free" mean semiconductor products that are compatible with the current RoHS requirements for all 6 substances, including the requirement that lead not exceed 0.1% by weight in homogeneous materials. Where designed to be soldered at high temperatures, TI Pb-Free products are suitable for use in specified lead-free processes.

Pb-Free (RoHS Exempt): This component has a RoHS exemption for either 1) lead-based flip-chip solder bumps used between the die and package, or 2) lead-based die adhesive used between the die and leadframe. The component is otherwise considered Pb-Free (RoHS compatible) as defined above.

Green (RoHS & no Sb/Br): TI defines "Green" to mean Pb-Free (RoHS compatible), and free of Bromine (Br) and Antimony (Sb) based flame retardants (Br or Sb do not exceed 0.1% by weight in homogeneous material)

⁽³⁾ MSL, Peak Temp. -- The Moisture Sensitivity Level rating according to the JEDEC industry standard classifications, and peak solder temperature.

⁽⁴⁾ Multiple Top-Side Markings will be inside parentheses. Only one Top-Side Marking contained in parentheses and separated by a "~" will appear on a device. If a line is indented then it is a continuation of the previous line and the two combined represent the entire Top-Side Marking for that device.

Important Information and Disclaimer: The information provided on this page represents TI's knowledge and belief as of the date that it is provided. TI bases its knowledge and belief on information provided by third parties, and makes no representation or warranty as to the accuracy of such information. Efforts are underway to better integrate information from third parties. TI has taken and continues to take reasonable steps to provide representative and accurate information but may not have conducted destructive testing or chemical analysis on incoming materials and chemicals. TI and TI suppliers consider certain information to be proprietary, and thus CAS numbers and other limited information may not be available for release.

In no event shall TI's liability arising out of such information exceed the total purchase price of the TI part(s) at issue in this document sold by TI to Customer on an annual basis.

TAPE AND REEL INFORMATION

QUADRANT ASSIGNMENTS FOR PIN 1 ORIENTATION IN TAPE

*All dimensions are nominal

| Device | Package Type | Package Drawing | Pins | SPQ | Reel Diameter (mm) | Reel Width W1 (mm) | A0 (mm) | B0 (mm) | K0 (mm) | P1 (mm) | W (mm) | Pin1 Quadrant |
|-----------------|--------------|-----------------|------|------|--------------------|--------------------|---------|---------|---------|---------|--------|---------------|
| TLV1117LV12DCYR | SOT-223 | DCY | 4 | 2500 | 330.0 | 12.4 | 7.05 | 7.4 | 1.9 | 8.0 | 12.0 | Q3 |
| TLV1117LV12DCYT | SOT-223 | DCY | 4 | 250 | 180.0 | 12.4 | 7.05 | 7.4 | 1.9 | 8.0 | 12.0 | Q3 |
| TLV1117LV15DCYR | SOT-223 | DCY | 4 | 2500 | 330.0 | 12.4 | 7.05 | 7.4 | 1.9 | 8.0 | 12.0 | Q3 |
| TLV1117LV15DCYT | SOT-223 | DCY | 4 | 250 | 180.0 | 12.4 | 7.05 | 7.4 | 1.9 | 8.0 | 12.0 | Q3 |
| TLV1117LV18DCYR | SOT-223 | DCY | 4 | 2500 | 330.0 | 12.4 | 7.05 | 7.4 | 1.9 | 8.0 | 12.0 | Q3 |
| TLV1117LV18DCYT | SOT-223 | DCY | 4 | 250 | 180.0 | 12.4 | 7.05 | 7.4 | 1.9 | 8.0 | 12.0 | Q3 |
| TLV1117LV25DCYR | SOT-223 | DCY | 4 | 2500 | 330.0 | 12.4 | 7.05 | 7.4 | 1.9 | 8.0 | 12.0 | Q3 |
| TLV1117LV25DCYT | SOT-223 | DCY | 4 | 250 | 180.0 | 12.4 | 7.05 | 7.4 | 1.9 | 8.0 | 12.0 | Q3 |
| TLV1117LV28DCYR | SOT-223 | DCY | 4 | 2500 | 330.0 | 12.4 | 7.05 | 7.4 | 1.9 | 8.0 | 12.0 | Q3 |
| TLV1117LV28DCYT | SOT-223 | DCY | 4 | 250 | 180.0 | 12.4 | 7.05 | 7.4 | 1.9 | 8.0 | 12.0 | Q3 |
| TLV1117LV30DCYR | SOT-223 | DCY | 4 | 2500 | 330.0 | 12.4 | 7.05 | 7.4 | 1.9 | 8.0 | 12.0 | Q3 |
| TLV1117LV30DCYT | SOT-223 | DCY | 4 | 250 | 180.0 | 12.4 | 7.05 | 7.4 | 1.9 | 8.0 | 12.0 | Q3 |
| TLV1117LV33DCYR | SOT-223 | DCY | 4 | 2500 | 330.0 | 12.4 | 7.05 | 7.4 | 1.9 | 8.0 | 12.0 | Q3 |
| TLV1117LV33DCYT | SOT-223 | DCY | 4 | 250 | 330.0 | 12.4 | 7.05 | 7.4 | 1.9 | 8.0 | 12.0 | Q3 |

TAPE AND REEL BOX DIMENSIONS

*All dimensions are nominal

| Device | Package Type | Package Drawing | Pins | SPQ | Length (mm) | Width (mm) | Height (mm) |
|-----------------|--------------|-----------------|------|------|-------------|------------|-------------|
| TLV1117LV12DCYR | SOT-223 | DCY | 4 | 2500 | 340.0 | 340.0 | 38.0 |
| TLV1117LV12DCYT | SOT-223 | DCY | 4 | 250 | 340.0 | 340.0 | 38.0 |
| TLV1117LV15DCYR | SOT-223 | DCY | 4 | 2500 | 340.0 | 340.0 | 38.0 |
| TLV1117LV15DCYT | SOT-223 | DCY | 4 | 250 | 340.0 | 340.0 | 38.0 |
| TLV1117LV18DCYR | SOT-223 | DCY | 4 | 2500 | 340.0 | 340.0 | 38.0 |
| TLV1117LV18DCYT | SOT-223 | DCY | 4 | 250 | 340.0 | 340.0 | 38.0 |
| TLV1117LV25DCYR | SOT-223 | DCY | 4 | 2500 | 340.0 | 340.0 | 38.0 |
| TLV1117LV25DCYT | SOT-223 | DCY | 4 | 250 | 340.0 | 340.0 | 38.0 |
| TLV1117LV28DCYR | SOT-223 | DCY | 4 | 2500 | 340.0 | 340.0 | 38.0 |
| TLV1117LV28DCYT | SOT-223 | DCY | 4 | 250 | 340.0 | 340.0 | 38.0 |
| TLV1117LV30DCYR | SOT-223 | DCY | 4 | 2500 | 340.0 | 340.0 | 38.0 |
| TLV1117LV30DCYT | SOT-223 | DCY | 4 | 250 | 340.0 | 340.0 | 38.0 |
| TLV1117LV33DCYR | SOT-223 | DCY | 4 | 2500 | 340.0 | 340.0 | 38.0 |
| TLV1117LV33DCYT | SOT-223 | DCY | 4 | 250 | 340.0 | 340.0 | 38.0 |

DCY (R-PDSO-G4)

PLASTIC SMALL-OUTLINE

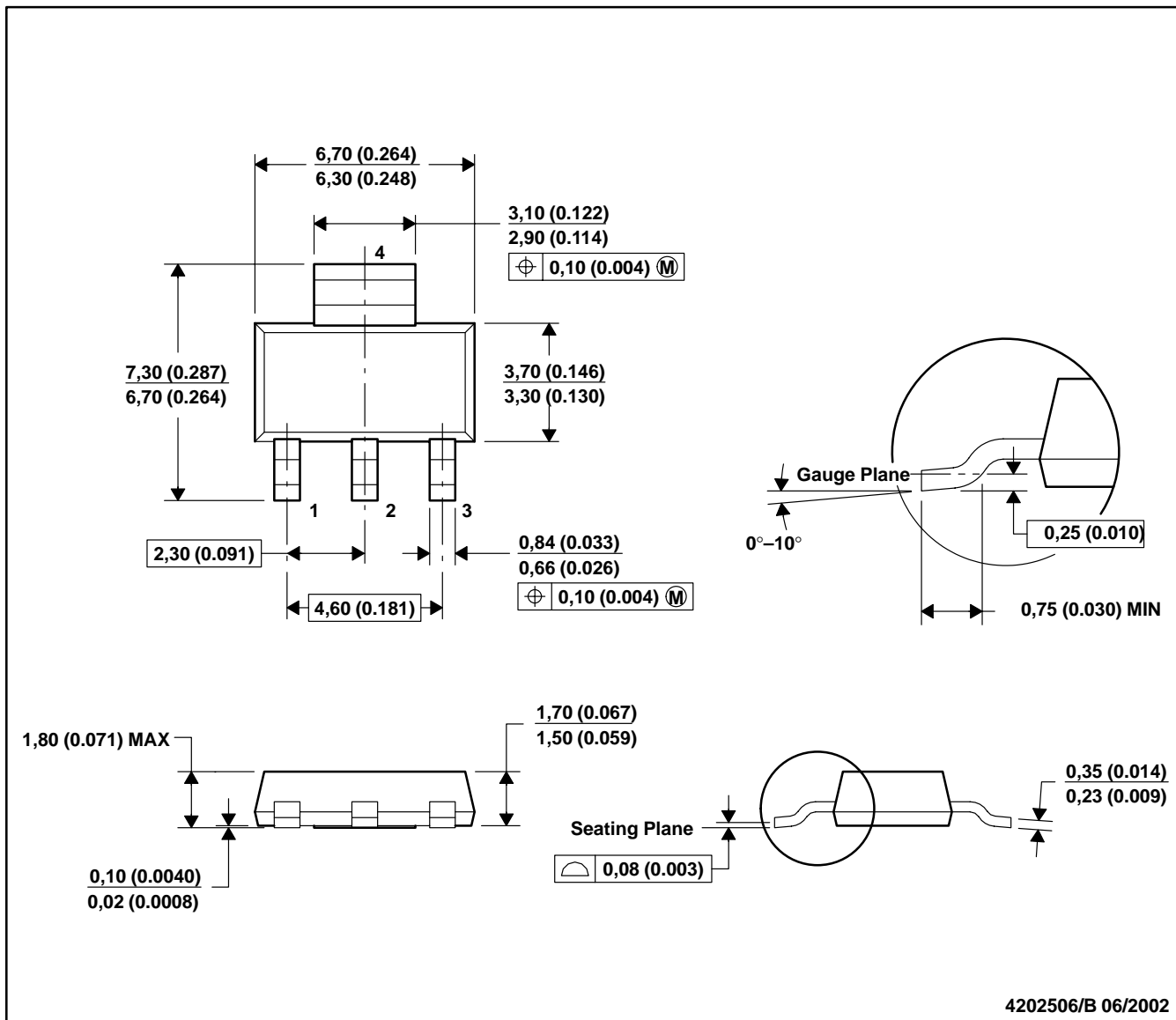

- NOTES: A. All linear dimensions are in millimeters (inches).
 B. This drawing is subject to change without notice.
 C. Body dimensions do not include mold flash or protrusion.
 D. Falls within JEDEC TO-261 Variation AA.

DCY (R-PDSO-G4)

PLASTIC SMALL OUTLINE

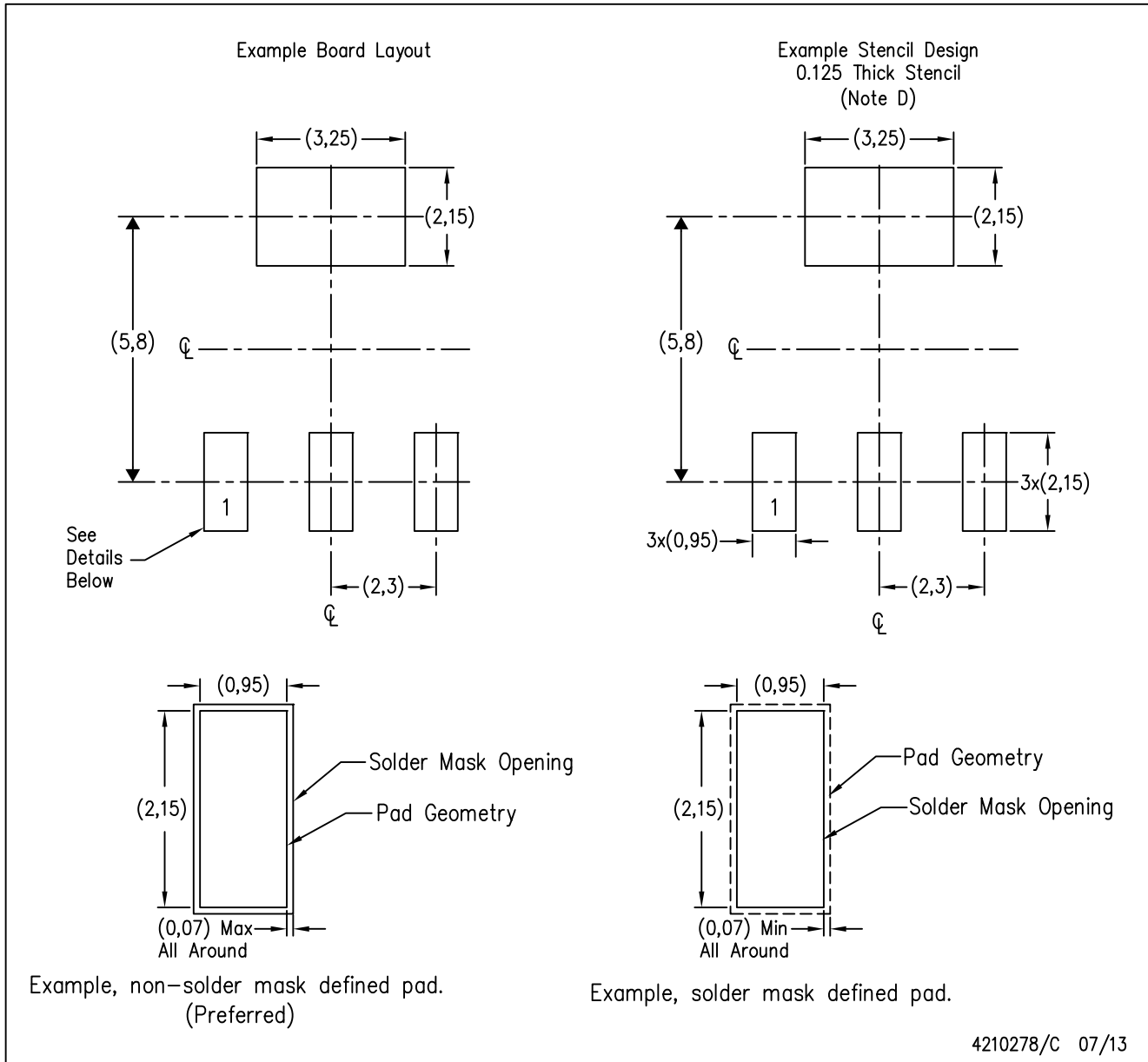

- NOTES:
- A. All linear dimensions are in millimeters.
 - B. This drawing is subject to change without notice.
 - C. Publication IPC-7351 is recommended for alternate designs.
 - D. Laser cutting apertures with trapezoidal walls and also rounding corners will offer better paste release. Customers should contact their board assembly site for stencil recommendations. Refer to IPC 7525 for stencil design considerations.

IMPORTANT NOTICE

Texas Instruments Incorporated and its subsidiaries (TI) reserve the right to make corrections, enhancements, improvements and other changes to its semiconductor products and services per JESD46, latest issue, and to discontinue any product or service per JESD48, latest issue. Buyers should obtain the latest relevant information before placing orders and should verify that such information is current and complete. All semiconductor products (also referred to herein as "components") are sold subject to TI's terms and conditions of sale supplied at the time of order acknowledgment.

TI warrants performance of its components to the specifications applicable at the time of sale, in accordance with the warranty in TI's terms and conditions of sale of semiconductor products. Testing and other quality control techniques are used to the extent TI deems necessary to support this warranty. Except where mandated by applicable law, testing of all parameters of each component is not necessarily performed.

TI assumes no liability for applications assistance or the design of Buyers' products. Buyers are responsible for their products and applications using TI components. To minimize the risks associated with Buyers' products and applications, Buyers should provide adequate design and operating safeguards.

TI does not warrant or represent that any license, either express or implied, is granted under any patent right, copyright, mask work right, or other intellectual property right relating to any combination, machine, or process in which TI components or services are used. Information published by TI regarding third-party products or services does not constitute a license to use such products or services or a warranty or endorsement thereof. Use of such information may require a license from a third party under the patents or other intellectual property of the third party, or a license from TI under the patents or other intellectual property of TI.

Reproduction of significant portions of TI information in TI data books or data sheets is permissible only if reproduction is without alteration and is accompanied by all associated warranties, conditions, limitations, and notices. TI is not responsible or liable for such altered documentation. Information of third parties may be subject to additional restrictions.

Resale of TI components or services with statements different from or beyond the parameters stated by TI for that component or service voids all express and any implied warranties for the associated TI component or service and is an unfair and deceptive business practice. TI is not responsible or liable for any such statements.

Buyer acknowledges and agrees that it is solely responsible for compliance with all legal, regulatory and safety-related requirements concerning its products, and any use of TI components in its applications, notwithstanding any applications-related information or support that may be provided by TI. Buyer represents and agrees that it has all the necessary expertise to create and implement safeguards which anticipate dangerous consequences of failures, monitor failures and their consequences, lessen the likelihood of failures that might cause harm and take appropriate remedial actions. Buyer will fully indemnify TI and its representatives against any damages arising out of the use of any TI components in safety-critical applications.

In some cases, TI components may be promoted specifically to facilitate safety-related applications. With such components, TI's goal is to help enable customers to design and create their own end-product solutions that meet applicable functional safety standards and requirements. Nonetheless, such components are subject to these terms.

No TI components are authorized for use in FDA Class III (or similar life-critical medical equipment) unless authorized officers of the parties have executed a special agreement specifically governing such use.

Only those TI components which TI has specifically designated as military grade or "enhanced plastic" are designed and intended for use in military/aerospace applications or environments. Buyer acknowledges and agrees that any military or aerospace use of TI components which have **not** been so designated is solely at the Buyer's risk, and that Buyer is solely responsible for compliance with all legal and regulatory requirements in connection with such use.

TI has specifically designated certain components as meeting ISO/TS16949 requirements, mainly for automotive use. In any case of use of non-designated products, TI will not be responsible for any failure to meet ISO/TS16949.

Products

| | |
|------------------------------|--|
| Audio | www.ti.com/audio |
| Amplifiers | amplifier.ti.com |
| Data Converters | dataconverter.ti.com |
| DLP® Products | www.dlp.com |
| DSP | dsp.ti.com |
| Clocks and Timers | www.ti.com/clocks |
| Interface | interface.ti.com |
| Logic | logic.ti.com |
| Power Mgmt | power.ti.com |
| Microcontrollers | microcontroller.ti.com |
| RFID | www.ti-rfid.com |
| OMAP Applications Processors | www.ti.com/omap |
| Wireless Connectivity | www.ti.com/wirelessconnectivity |

Applications

| | |
|-------------------------------|--|
| Automotive and Transportation | www.ti.com/automotive |
| Communications and Telecom | www.ti.com/communications |
| Computers and Peripherals | www.ti.com/computers |
| Consumer Electronics | www.ti.com/consumer-apps |
| Energy and Lighting | www.ti.com/energy |
| Industrial | www.ti.com/industrial |
| Medical | www.ti.com/medical |
| Security | www.ti.com/security |
| Space, Avionics and Defense | www.ti.com/space-avionics-defense |
| Video and Imaging | www.ti.com/video |

TI E2E Community

e2e.ti.com